

**WR-1202-JLED Series Optical Receiver**

**1 Product Overview**

**WR-1202-JLED** is a new modular two-output CATV network optical receiver. It adopts modular design, use more flexible. Microprocessor control, digital display the parameters, the engineering debug is especially easy. It is the main equipment to build the CATV network.

**2 Features**

- High response PIN photoelectric conversion tube.
- Optimized circuit design, SMT process production, optimized signal path, make the photoelectric signal transmission more smooth.
- Specialized RF attenuation chip, with good RF attenuation and equilibrium linear, high accuracy.
- GaAs amplifier device, power doubler output, with high gain and low distortion.
- Single Chip Microcomputer (SCM) control equipment working, LCD display the parameters, convenience and intuitive operation, and stable performance.
- Excellent AGC performance, when the input optical power range is  $-9\sim+2\text{dBm}$ , the output level keep unchanged, CTB and CSO basically unchanged.
- Reserved data communication interface, can connect with the Ethernet transponder, access to network management system.
- Return emission can select burst mode to sharply decrease the noise convergence and reduce the forepart receiver number.
- ONU module optional.

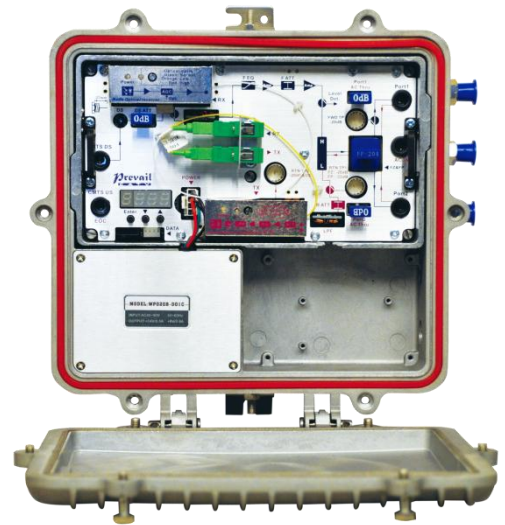

**3 Block Diagram**

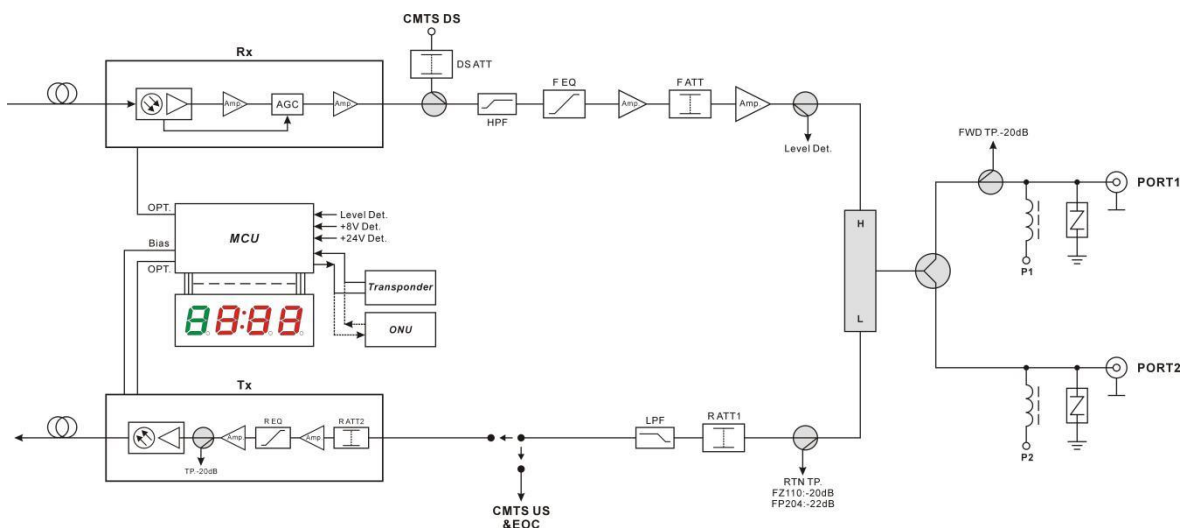

## 4 Technical Parameters

Item	Unit	Technical Parameters	
<b>Optical Parameters</b>			
Receiving Optical Power	dBm	-8 ~ +2	
Optical Return Loss	dB	>45	
Optical Receiving Wavelength	nm	1100 ~ 1600	
Optical Connector Type		FC/APC, SC/APC or specified by the user	
Fiber Type		Single Mode	
<b>Link Performance</b>			
C/N	dB	≥ 51 (-1dBm input)	
C/CTB	dB	≥ 65	Output Level 106dBμV EQ 8dB 79ch PAL-D
C/CSO	dB	≥ 60	
<b>RF Parameters</b>			
Frequency Range	MHz	54/85/105/258 ~ 1218	
Flatness in Band	dB	±0.75	
Rated Output Level	dBμV	≥ 106	
Max Output Level	dBμV	≥ 108	
Output Return Loss	dB	(54/85/105/258 ~550MHz)≥16/(550~1218MHz)≥14	
Output Impedance	Ω	75	
Electronic Control EQ Range	dB	0~15	
Electronic Control ATT Range	dBμV	0~20	
<b>Return Optical Emission Part</b>			
<b>Optical Parameters</b>			
Optical Transmit Wavelength	nm	1310±10, 1550±10 or specified by the user	
Output Optical Power	mW	0.5, 1, 2	
Optical Connector Type		FC/APC, SC/APC or specified by the user	
<b>RF Parameters</b>			
Frequency Range	MHz	5 ~ 42/65/85/204	
Flatness in Band	dB	±0.75	
Input Level	dBμV	72 ~ 85	
Output Impedance	Ω	75	
NPR Dynamic Range	dB	≥15 (NPR≥30 dB) Use DFB laser	≥10(NPR≥30 dB) Use FP laser
<b>General Performance</b>			
Supply Voltage	V	A: AC (150~265)V; B: AC (35~90)V	
Operating Temperature	℃	-40~60	
Storage Temperature	℃	-40~65	
Relative Humidity	%	Max 95% no condensation	
Consumption	VA	≤ 20	
Dimension	mm	280 (L) *260 (W) *70 (H)	
Net Weight	kg	2.8	
<b>Burst Mode (Select this mode, see below)</b>			
Optical Output Power (Close the burst mode)	dBm	-30	
Laser Turn On Threshold	dBμV	≥70	
Laser Turn Off Threshold	dBμV	≤62	
Laser Turn On Time (t1)	us	0.5≤ t1 ≤1	
Laser Turn Off Time (t2)	us	0.5≤ t2 ≤1.5	

## 5 Relation Table of Input Optical Power and CNR

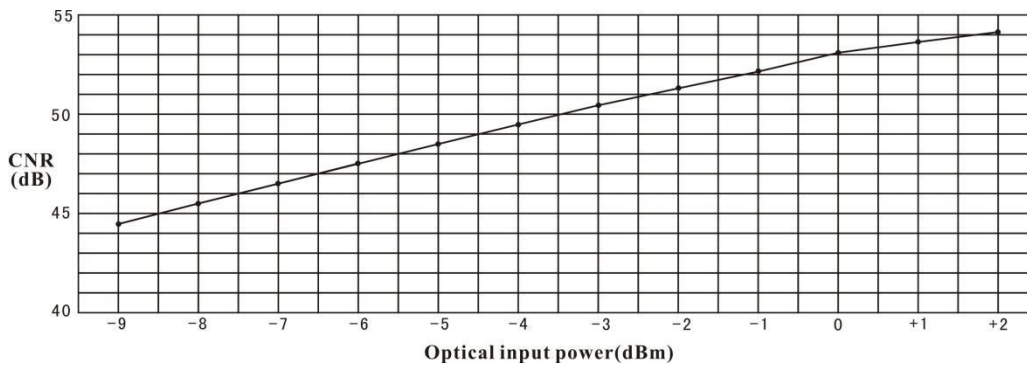

## 6 Structure Diagram

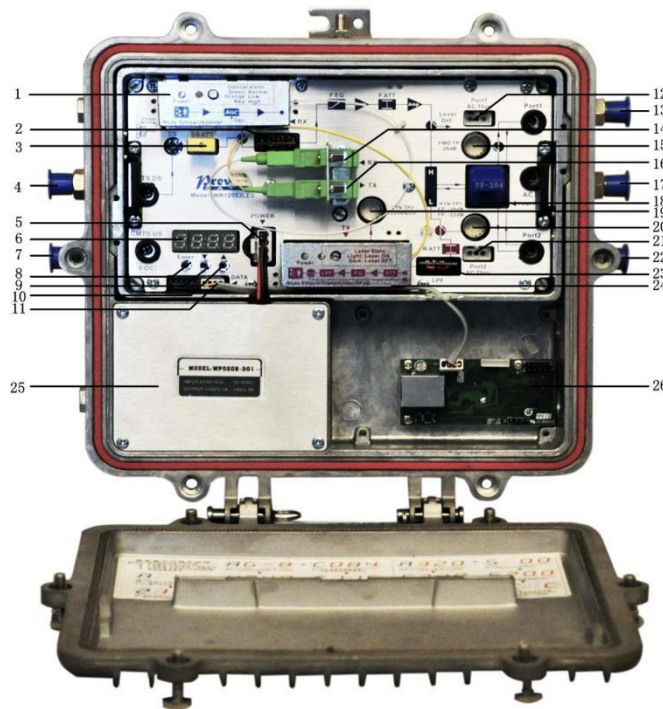

1. Optical receiving module	2. HPF (high pass filter)
3. DS attenuator	4. CMTS DS port(without installing by default)
5. Mainboard power supply interfafce	6. Seven-segment digital tube status display
7. CMTS US port/EOC signal interface (without installing by default)	8. Control mode selectable button (Enter)
9. Parameters adjustment button (Down)	10. Paramenters adjustment button (Up)
11. Mainboard network mangement interface	12. Power-pass inserter
13. Output port1	14. Optical input port
15. RF output test port (-20dB)	16. Optical output port
17. AC60V input port	18. Splitter or tap output
19. Laser drive level test port (-20dB)	20. Reverse path RF input test port (-20dB)
21. Power-pass inserter	22. Output port2
23. LPF (low pass filter)	24. Optical transmitter module
25. Switching power supply	26. ONU unit or transponder

## 7 Function Display and Operating Instruction

### Function Display and Operating Instruction

Enter Cyclical page turning and input validation

- ▲ Up button, long-press for 3 sec then entering into adjustment mode
- ▼ Down button, long-press for 3 sec then entering into adjustment mode

Note: The content in gridlines will be changed according to the reverse path configuration

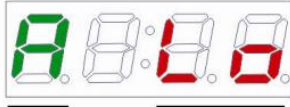

**A** : Rx Input Optical Power(dBm)  
**L0** : Means that the optical power is low or none

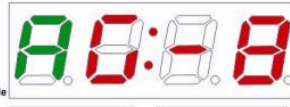

**AG** : Optical AGC setting range (-8~-6dBm)



**C** : The actual number of channels setting  
 In order to calculate the displayed value of output level



**4** : +24V power supply detection(V)

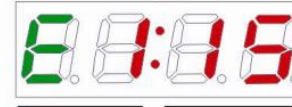

**E1** : Forward path equalizer setting(Max:15dB)



**2** : The output level(dBuV)



**3** : +8V power supply detection(V)



**A1** : Forward path attenuator setting(Max:20dB)

